

RFID System V680 Series

Global Standard of Manufacturing Site Visualization



» Visualization of communication

» Compliant with ISO/IEC18000-3 international standards

» Available variation

We enable the visualization of manufacturing sites.

The V680 series features electromagnetic induction and proprietary technologies to enable high-speed, high-reliability communication. This series of devices includes many useful startup and operational features, such as the visualization of communication status.

Even in global markets and manufacturing bases, these devices comply with the radio laws in all major countries to enable a consistent global deployment that provides traceability and production information management capability.

Our wide variety of RF tags, amplifiers, and controllers enables the visualization of all kinds of manufacturing sites, which helps increase productivity and improve quality.



V680 series

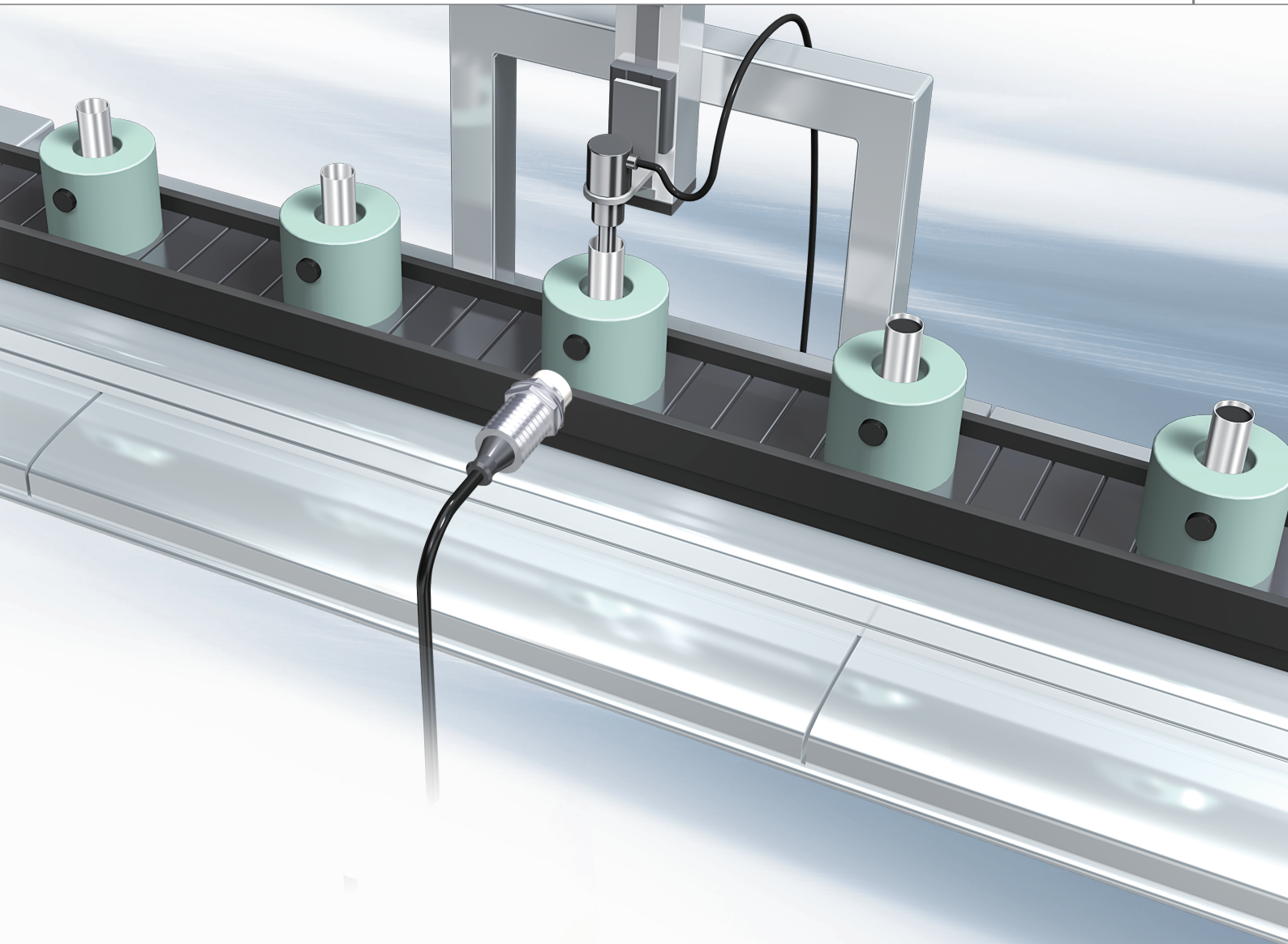

Globally deployable



These devices are compliant with the ISO/IEC18000-3 international standard for RFID systems using the 13.56-MHz band that has become the global standard. These devices also comply with the radio laws of all major countries giving you peace of mind for deployments in global markets and manufacturing bases.

Custom system configurations



We offer a total solution with an extensive product lineup to support any application and objective including extremely small, 8-kbyte RF tags that do not need batteries, antennas, amplifiers, and controllers.

Visualization of communication



Visualization of the 7 communication modes provided on the front panels of amplifiers and controllers enables easy diagnosis without the need for host devices. In addition to making status confirmation easier for on-site operators, this also significantly reduces the time and labor required for installation, tuning, startup, and maintenance.

Globally deployable

Because these devices are compliant with ISO/IEC18000-3 (ISO/IEC15693) international standards, you can export these devices and easily integrate them with other equipment in local sites and facilities that are also compliant with ISO standards for overseas production.

Compliant with ISO/IEC18000-3 international standards

These devices are compliant with ISO/IEC18000-3 (ISO/IEC15693) international standards, offering peace of mind in relocating and exporting equipment to overseas locations.

No special certification required for use in all major countries

Globally deployable without any modification

Globally deployable in 51 countries around the world

Wireless device certification has been acquired in 51 countries, including Japan, European countries, and America, offering you peace of mind in utilizing these devices all around the world.

Contact us for more information on other supported countries. Visit the Omron website for the latest information on the radio device certification status of each country.

<http://www.ia.omron.com/>

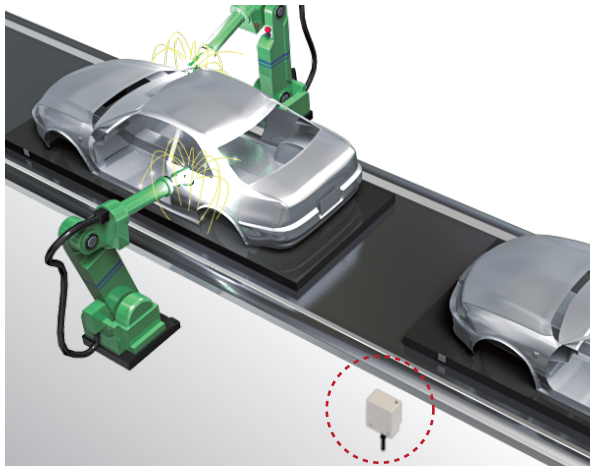

Assembly line job instructions

Automated reading of vehicle model information, job instructions, and process history stored in RF tags prevents human errors and reduces costs related to defects and waste, even in mixed lines.

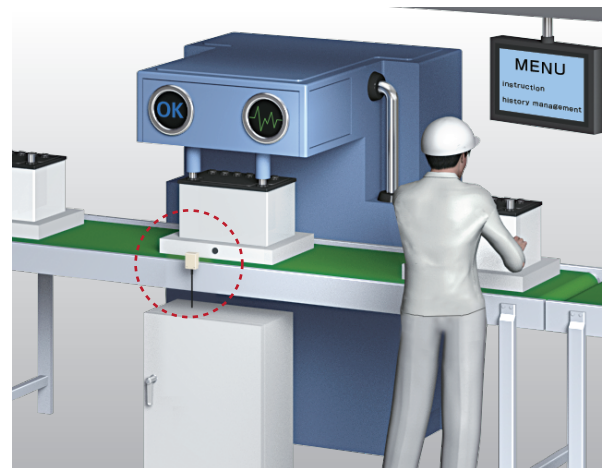

Traceability management

At each process, jobs are performed per the job instructions in RF tags followed by writing the results of the job into these RF tags. Central management of workers, manufacturing dates, and inspection data enables a reliable system of product traceability.

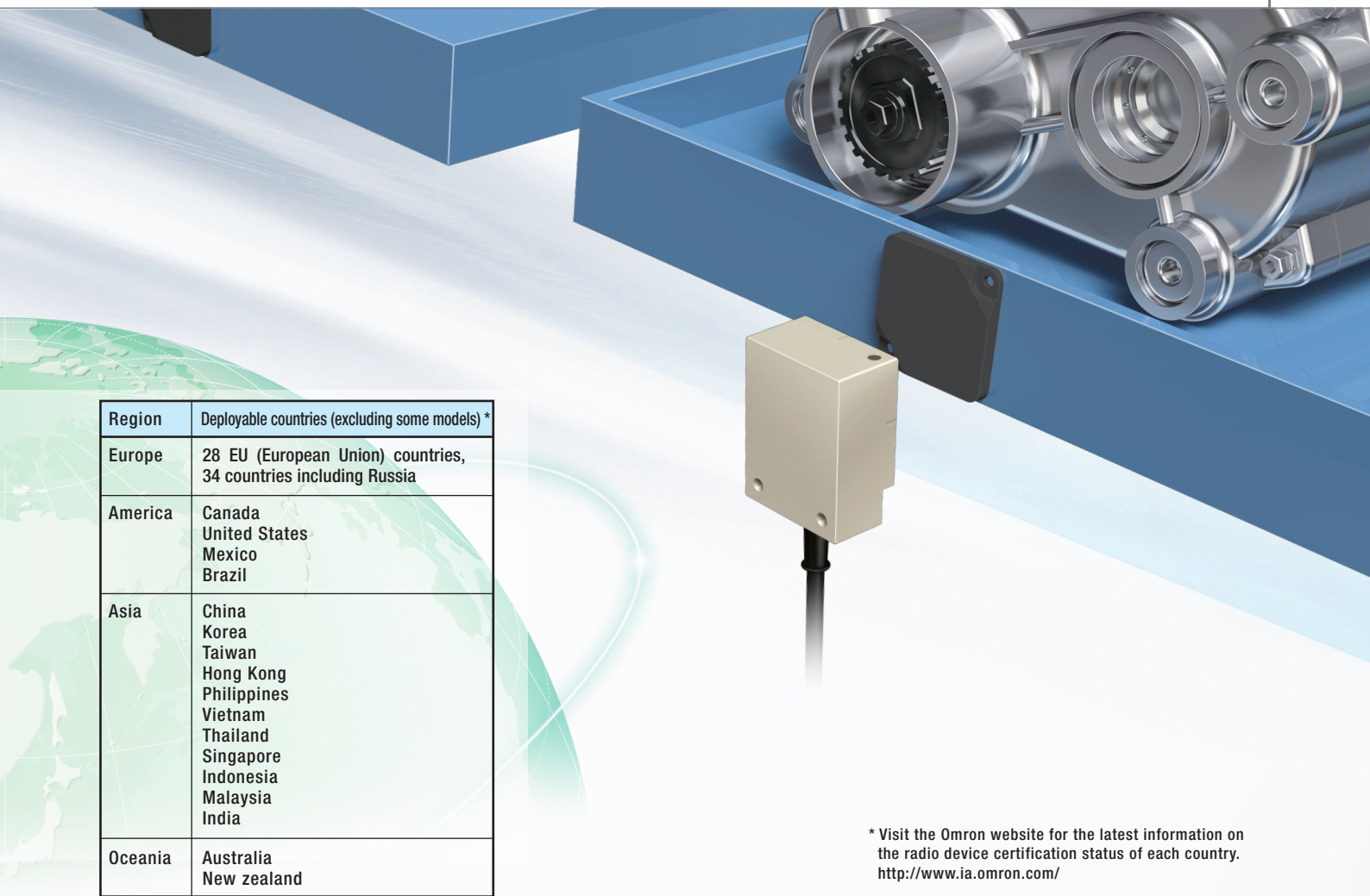

Region	Deployable countries (excluding some models) *
Europe	28 EU (European Union) countries, 34 countries including Russia
America	Canada United States Mexico Brazil
Asia	China Korea Taiwan Hong Kong Philippines Vietnam Thailand Singapore Indonesia Malaysia India
Oceania	Australia New Zealand

* Visit the Omron website for the latest information on the radio device certification status of each country.
<http://www.ia.omron.com/>

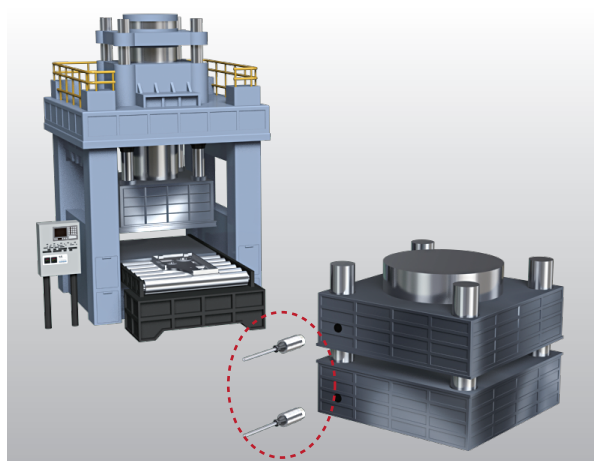

History and service life management

Installing RF tags to molds and antennas to molding machines enables mold information to be read from the RF tags. This enables easy management of cumulative shot time and shot counts, which impacts mold quality. If the wrong mold is accidentally mounted, automatic mold checks performed before the molding process can prevent production of defects.

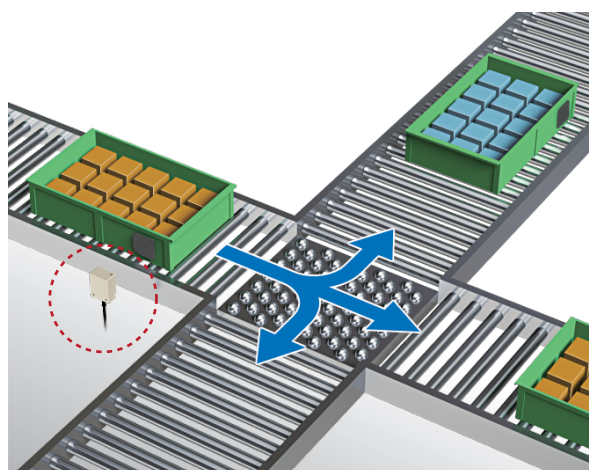

Line sorting

Installing antennas at branch points enables you to easily construct sorting systems that read RF tag information on containers and use PLCs or other control systems to perform point sorting. The lack of mechanical structures, such as mechanical flags, enables the build-out of maintenance-free systems with very few failures.

Massive System Variation

We provide a wide variety of RFID components so that users can customize configurations for any installation space or objective, from replacing multiple sensor-based systems to managing large amounts of manufacturing data.

RF tags



This information medium is used to tie objects and information together. Our lineup includes devices of 1 kbyte to 8 kbytes. Select components based on storage amount and size of installation object.

1k
bytes

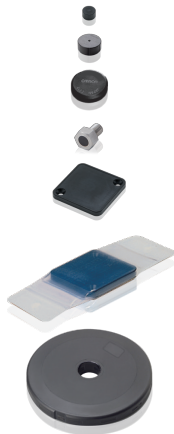

2 k
bytes

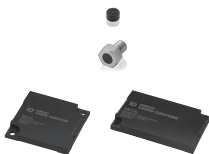

8 k
bytes



Antennas



These devices are used to communicate with RF tags to read and write data. Select components based on communication distance and installation space.

Detachable
amplifiers
Cylindrical
type



Detachable
amplifiers
Square
type



Built-in
amplifiers
Square
type



Amplifiers & Controllers

Large capacity & High-speed

ID controllers | 8-kbyte data bursts

High-speed communication between Omron machine automation controllers and PLCs

RFID units | 8-kbyte data bursts

ID sensor units | 8-kbyte data bursts

Supports DeviceNet™ Supports PROFIBUS

DeviceNet ID slave | 58-byte data

PROFIBUS ID slave | 58-byte data

Optimal for use in device identification

ID flag sensors | 2 bytes (16 bits) data

Controls RFID operations including the sending of read data to host devices and writing instructions from host devices to RF tags.



High-speed communication of up to 27 kbps via the 13.56-MHz band. Using the "Self-execution Mode" eliminates the need to access host devices, which significantly reduces takt time.

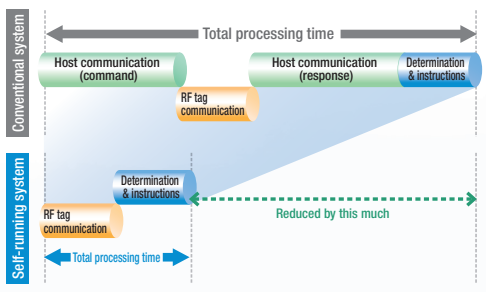

Communication units enable direct connectivity between RFID systems and the NJ/NX series of Omron machine automation controllers and CS/CJ series of PLCs. Data reads/writes can be easily performed by simply setting parameters in the PLC memory area. Simple device configuration, in comparison with serial communication, is coupled with high-speed data processing. Communication programs can be easily built using the ladder program function blocks library (FB).

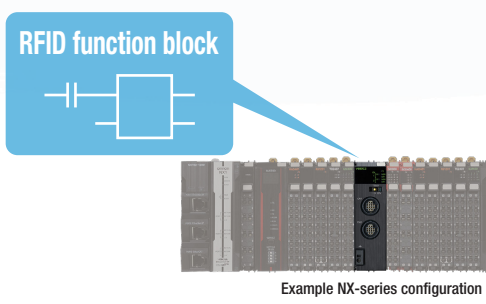

Manage manufacturing site information using open networks. Up to 58 bytes of data communication can be enabled simply by changing DIP switch settings.

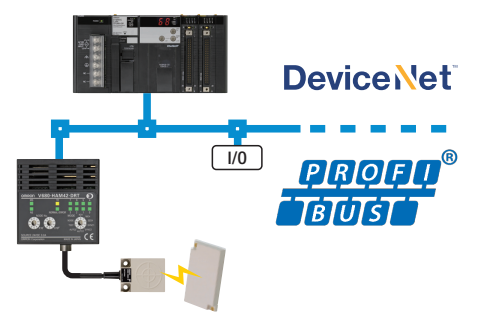

Includes functionality equivalent to 16 detection sensors. This means that approximately 64,000 identifications using 16-bit RF tag communication can be performed. This can be used in line sorting operations, device identification, and process progress management.

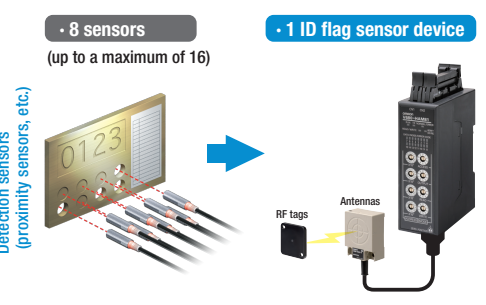

We also provide handheld reader/writers.

Visualization of communication

Amplifiers and controllers are equipped with display functionality for startup, tuning, and easy diagnostics operations. This functionality increases on-site startup and maintenance efficiency.

Easily perform RFID system diagnosis

Stability of communication can be confirmed via amplifiers and controllers directly without the need to use a PC or other host device.

Visualization

1

Communication Stability

Visualization

2

Noise Status

Visualization

3

Error Causes

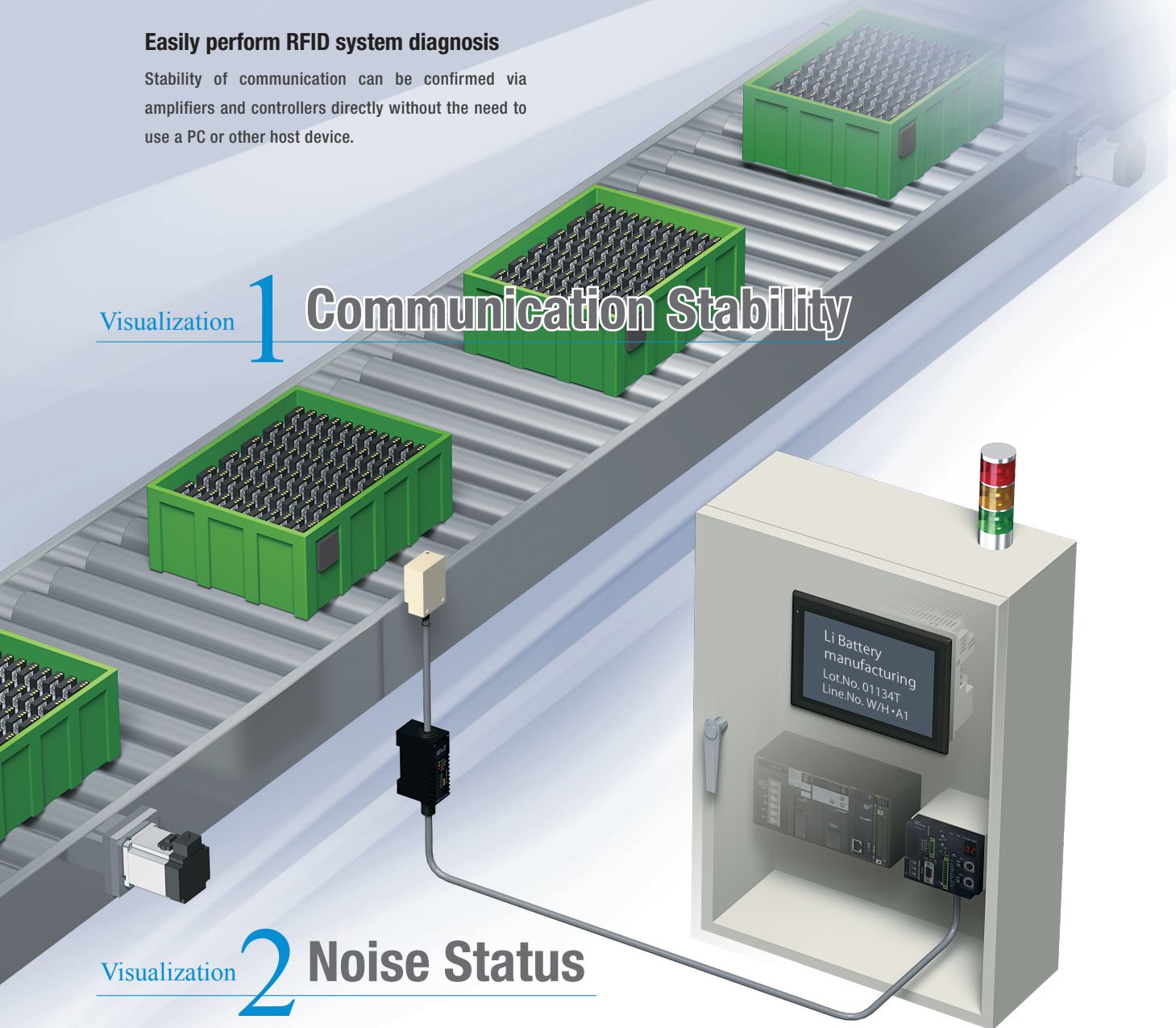

Visualization 1 Communication Stability

Visualization of communication stability

The stability of communication between antennas and RF tags can be checked by anyone, anytime, with time and cost reduction.

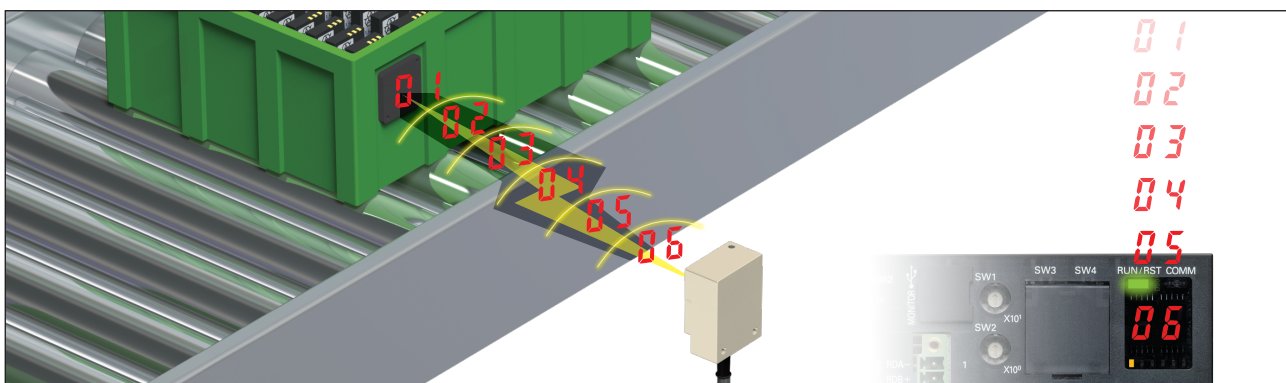

6-level indication of distance between antennas and RF tags

ID controllers

ID flag sensors

Distance in relation to the range of communication between antennas and RF tags is indicated in 6 levels. Installation positions of antennas and RG tags can be easily set and checked.



6-level indication of distance between antennas and RF tags

Using the feature as a guide during installation prevents variance caused by the presence of people and the environment.

Speed level measuring mode

ID controllers

This mode enables the confirmation of RF tag movement speed and the number of available bytes. Devices repeatedly communicate with moving RF tags to display the communication success rate and speed level between a range of levels from 01 to 99.



Successful communication of at least 100 times

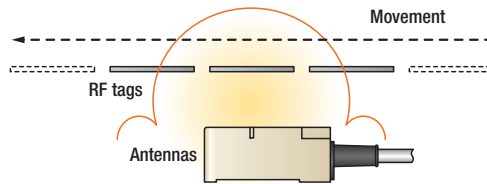

*Data is not written to RF tags during the speed level measuring mode (writes).

Communication success rate measuring mode

ID controllers

This mode is used to check the communication success rate between antennas and RF tags. The communication process is executed 100 times without any retries to display a communication success rate between levels of 01 to 99.



Successful communication of 23 times

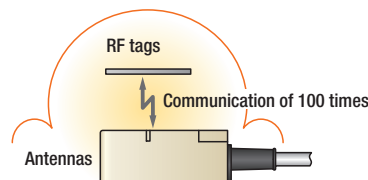

Visualization 2 Noise Status

Visualization of noise status

This feature is used to check if there is any noise in the area that could cause communication issues. This feature is useful for pre-checks and for reducing downtime when communication errors occur. This feature also gives you peace of mind in deploying RFID systems in environments near sources of drive power, which are prone to noise, and other environments with poor radio signal reception.

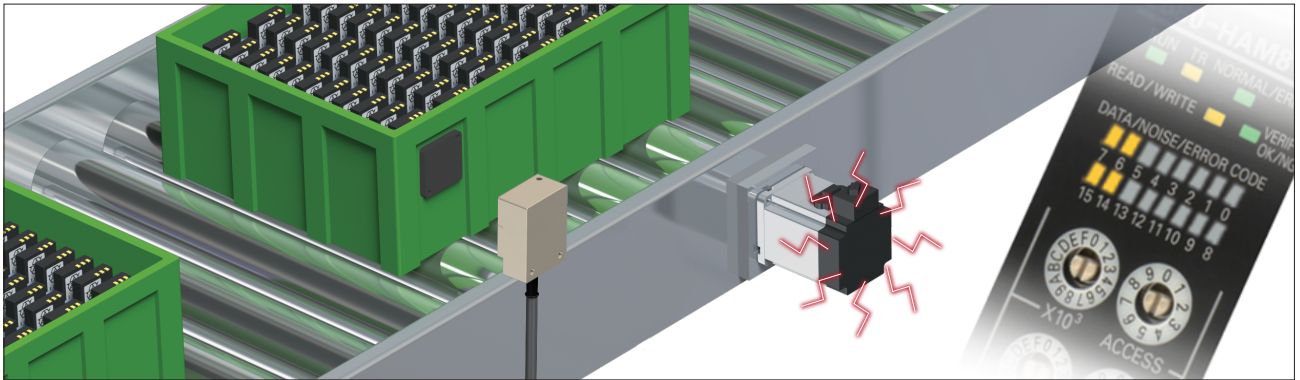

Noise level measuring mode

ID controllers

This feature measures the noise level in the space between RF tag and antenna installations and displays the noise level between a range of 00 to 99. The ambient noise level, source of noise, and effect of noise reduction efforts all appear as level indicators for ease of use and peace of mind.

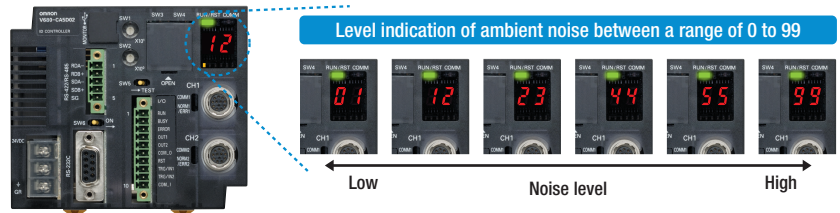

LEDs indicate noise levels

DeviceNet ID slave
PROFIBUS ID slave

ID flag sensors

A combination of LEDs is used to indicate ambient noise status.



Visualization 3 Error Causes

Visualization of error causes

This feature enables you to see when line errors occur and their causes. This feature is useful for reducing downtime when issues occur.

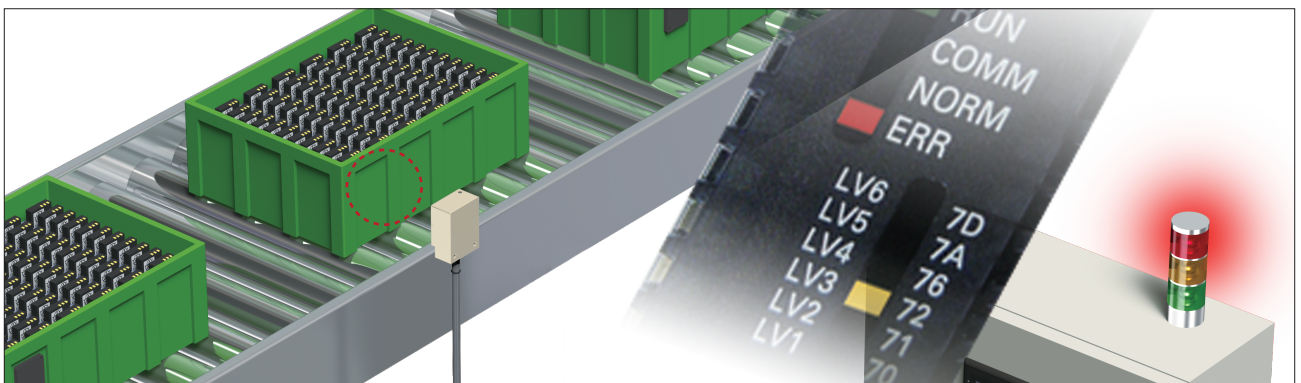

Confirmation of line errors

LEDs in amplifiers indicate error information when errors occur. This feature enables you to quickly confirm line errors, which helps to reduce downtime when issues occur.

Amplifier (ID controller)



Amplifier (ID controller)

ERR : Red LED lights when communication with an RF tag ends in failure

Error indicators (yellow LED lights)

- 7D : Write protect error
- 7A : Address error
- 76 : RF tag memory error
- 72 : RF tag missing error
- 71 : Verification error
- 70 : RF tag communication error

Type of error indicated by LEDs

DeviceNet ID slave
PROFIBUS ID slave

ID flag sensors

Combinations of red flashing LEDs are used to indicate RF tag communication errors, RF tag missing errors, and other error causes.



DeviceNet ID slave
PROFIBUS ID slave

Example error indication



ID flag sensors

Example error indication



Efficient Management of RF Tag Memory Maps

V680 User Support Software | ID Map Manager

What information is written to and read from RF tags at what process? The amount of data required for operations is enormous and changes frequently. Manual verification and management takes significant time and is also prone to human error. ID Map Manager is a memory map creation, management, and testing tool designed to eliminate these issues and help make operations more efficient. Centralized management of RF tag data helps reduce time required for memory allocation, design, and verification processes.

Easily access desired addresses

Directly read and write RF tags

Displays data mappings in an easy-to-understand format

Create documents with one click*

Easily register new tags using templates

The screenshot shows the ID Map Manager software interface. On the left is a tree view of processes under 'master.vmp'. The main area displays a table of memory mappings with columns: Name1, Name2, Name3, Address, Bytes, Designation, Write, Remarks, and Data. Below the table is an 'Edit Memory Map' dialog box with fields for Name1, Address(Dec), Number of Bytes(Dec), Data Designation, and Remark, along with 'Add', 'Edit', and 'Available Space' buttons.

Name1	Name2	Name3	Address	Bytes	Designation	Write	Remarks	Data
Process1	Process1-1	Process1-1-1	0010	1	HEX		For a note	AA
		Process1-1-2	0011	1	HEX		1:A 2:B 3:C	55
		Process1-1-3	0012	1	HEX		1-1-3	AA
		Process1-1-4	0013	1	HEX			55
		Process1-1-5	0014	1	HEX			AA
		Process1-1-6	0015	1	HEX			55
		Process1-1-7	0016	1	HEX			AA
	Process1-2	Process1-2-1	0017	1	HEX			DD
		Process1-2-2	0018	1	HEX			AA
		Process1-2-3	0019	1	HEX			55
		Process1-2-4	0020	1	HEX			AA
		Process1-2-5	0021	1	HEX			55
		Process1-2-6	0022	1	HEX			AA
		Process1-2-7	0023	1	HEX			55
	Process2	Process2-1	0024	1	ASCII		Line code	K
		Process2-1-2	0025	1	ASCII		Name code	V
		Process2-1-3	0026	1	ASCII			E
		Process2-2-1	0027	1	HEX		Other	55
		Process2-2-2	0028	1	HEX			AA
		Process2-2-3	0029	1	HEX			55
		Process2-2-4	0030	1	HEX			AA
		Process2-2-5	0031	1	HEX			55
		Process2-2-6	0032	1	HEX			AA
	Process3		0033	1	HEX		rsawr	55

Per-process testing

Select the desired check boxes to perform read and write tests on only the specified processes. This feature enables you to easily test and tune memory maps.

Name1	Name2	Name3	Address	Bytes	Design
<input checked="" type="checkbox"/>	Process1	Process1-1	000A	1	HEX
<input checked="" type="checkbox"/>		Process1-1-2	000B	1	HEX
<input checked="" type="checkbox"/>		Process1-1-3	000C	1	HEX
<input checked="" type="checkbox"/>		Process1-1-4	000D	1	HEX
<input checked="" type="checkbox"/>		Process1-1-5	000E	1	HEX
<input checked="" type="checkbox"/>		Process1-1-6	000F	1	HEX

*Create documents with one click

Click the Print Preview button to instantly create documents in template formats. Data can also be output as CSV files so that you can create original formats in Excel or other applications.

The screenshot shows a printed document with a table of memory mappings, similar to the one in the main screenshot, but with a different layout and styling.

System Configuration

Connect V680 Antennas and Amplifier Units to a V680-series Controller, and read or write data from or to RF Tags.

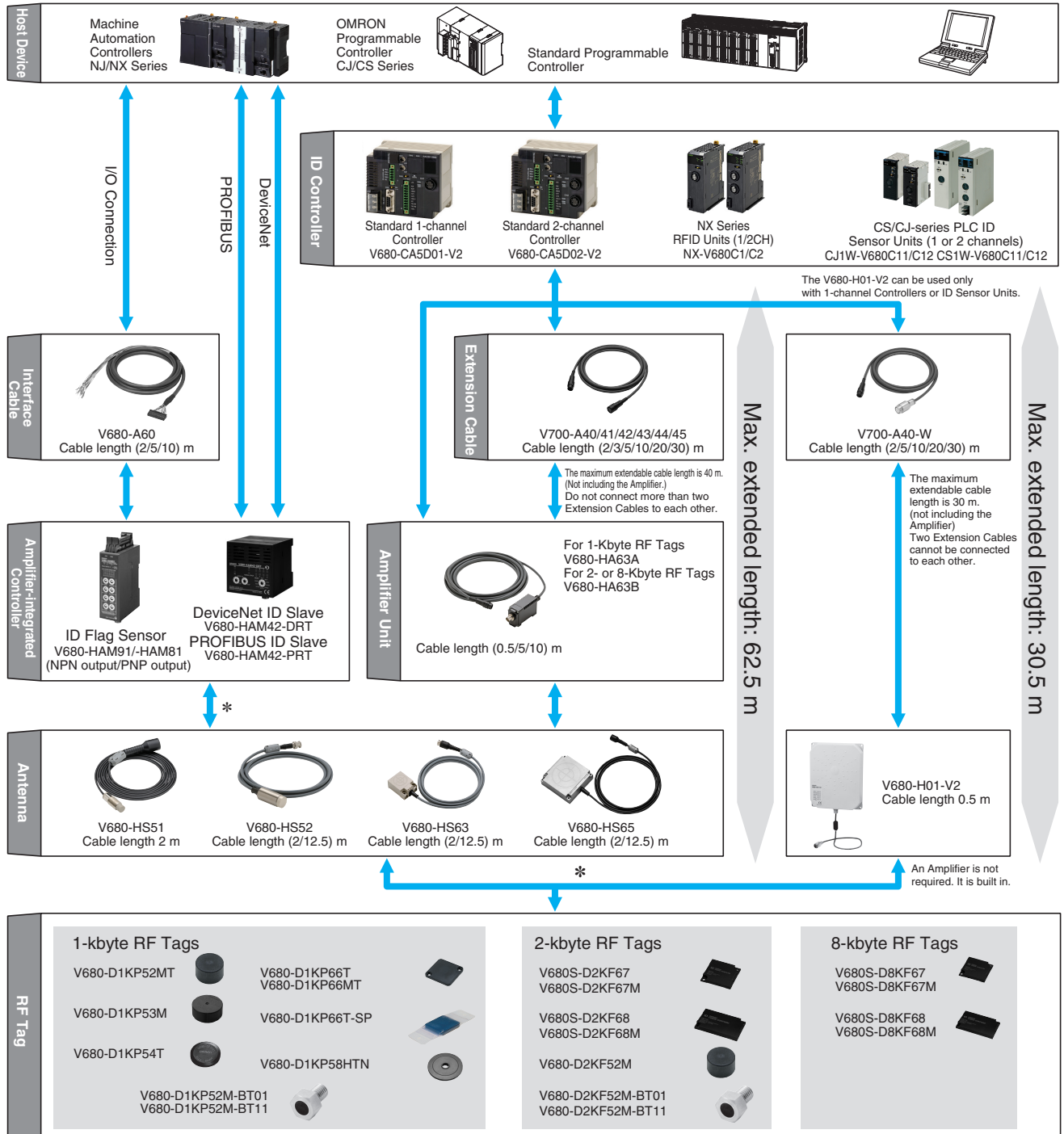











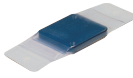

* For information on the combination that can be used, refer to the data sheet (Cat. No. Q267).

- We also provide handheld reader/writers. Refer to the data sheet (catalog No. Q267) for more information.
- Wireless device certification has been acquired in 51 countries, including Japan, European countries, and America, offering you peace of mind in utilizing these devices all around the world.
- Some models cannot be used in all countries. Visit the Omron website for the latest information on the radio device certification status of each country and the specific devices that are certified. <http://www.ia.omron.com/>
- Contact us for more information on other supported countries.



Ordering Information

RF Tag

Type	Memory capacity	Appearance	Size	Metallic compatibility	Model
Battery-less	1 kbyte		8 dia. × 5 mm	For embedding in metallic or non-metallic surface	V680-D1KP52MT
			10 dia. × 4.5 mm	For embedding in metallic or non-metallic surface	V680-D1KP53M
			20 dia. × 2.7 mm	For flush mounting on non-metallic surface	V680-D1KP54T
			34 × 34 × 3.5 mm	For flush mounting on metallic surface	V680-D1KP66MT
				For flush mounting on non-metallic surface	V680-D1KP66T
			95 × 36.5 × 6.5 mm	For flush mounting on non-metallic surface	V680-D1KP66T-SP
			80 dia. × t10 mm	For flush mounting on non-metallic surface	V680-D1KP58HTN
		M10 × 12 mm	For mounting as bolts	V680-D1KP52M-BT01 *	
		M8 × 12 mm		V680-D1KP52M-BT11 *	
	2 kbytes		8 dia. × 5 mm	For embedding in metallic or non-metallic surface	V680-D2KF52M
					40 × 40 × 5 mm
		For flush mounting on non-metallic surface	V680S-D2KF67		
			86 × 54 × 10 mm	For flush mounting on metallic surface	V680S-D2KF68M
				For flush mounting on nonmetallic surface	V680S-D2KF68
			M10 × 12 mm	For mounting as bolts	V680-D2KF52M-BT01 *
M8 × 12 mm			V680-D2KF52M-BT11 *		
8 kbytes		40 × 40 × 5 mm	For flush mounting on metallic surface	V680S-D8KF67M	
			For flush mounting on non-metallic surface	V680S-D8KF67	
		86 × 54 × 10 mm	For flush mounting on metallic surface	V680S-D8KF68M	
			For flush mounting on nonmetallic surface	V680S-D8KF68	

* Place orders in units of boxes (containing 20 units).

Antenna (Detachable Amplifier Unit Type)



Type	Appearance	Size	Cable length	Model	
Cylindrical	Standard cable, waterproof connector 	M22 × 65 mm	2 m	V680-HS52-W 2M	
			12.5 m	V680-HS52-W 12.5M	
	Flexible cable, nonwaterproof connector		2 m	V680-HS52-R 2M	
			12.5 m	V680-HS52-R 12.5M	
Square	Standard cable, waterproof connector 	M12 × 35 mm	2 m	V680-HS51 2M	
			Flexible cable, nonwaterproof connector	40 × 53 × 23 mm	2 m
	12.5 m				V680-HS63-W 12.5M
	Standard cable, waterproof connector		100 × 100 × 30 mm	2 m	V680-HS65-W 2M
12.5 m		V680-HS65-W 12.5M			
Flexible cable, nonwaterproof connector		2 m	V680-HS65-R 2M		
		12.5 m	V680-HS65-R 12.5M		

Antenna with Built-in Amplifier



Type	Appearance	Size	Cable length	Model
Square		250 × 200 × 35 mm	0.5 m *	V680-H01-V2

* Use an Antenna Cable to connect the Antenna to the Controller.
The maximum cable length is 30.5 m.



Amplifier Unit

Type	Appearance	Size	Cable length	Model
For 1-kbyte memory		25 × 40 × 65 mm	0.5 m	V680-HA63A 0.5M
			5 m	V680-HA63A 5M
			10 m	V680-HA63A 10M
For 2-/8-kbyte memory			0.5 m	V680-HA63B 0.5M
			5 m	V680-HA63B 5M
			10 m	V680-HA63B 10M

ID Controller

Type	No. of connectable Amplifiers	Appearance	Size	Communication interface	Model
DC power supply	Single		105 × 90 × 65 mm	RS232C, RS422/RS485	V680-CA5D01-V2
	Dual				V680-CA5D02-V2

RFID Units

RFID Units	Appearance	Product name	Amplifier/Antenna	No. of unit numbers used	Model
NX-series RFID Units		RFID Units	V680 series	1	NX-V680C1
				2	NX-V680C2

ID Sensor Units

Type	Appearance	Connected ID System	External power supply	No. of unit numbers used	Current consumption (A)			Model
					5 V	24 V	External	
CJ Special I/O Unit		V680 Series	-	1 unit number	0.26	0.13 *	-	CJ1W-V680C11
				2 unit number	0.32	0.26	-	CJ1W-V680C12



Type	Appearance	Connected ID System	External power supply	No. of unit numbers used	Current consumption (A)			Model
					5 V	26 V	External	
CS Special I/O Unit		V680 Series	-	1 unit number	0.26	0.13 *	-	CS1W-V680C11
				2 unit number	0.32	-	0.36	CS1W-V680C12

* When connected to the V680-H01: 0.28 A

Amplifier-integrated Controller (DeviceNet ID Slave/PROFIBUS ID Slave)

Appearance	Size	Network Compatibility	Model
	65 × 65 × 65 mm	DeviceNet	V680-HAM42-DRT
		PROFIBUS	V680-HAM42-PRT

Amplifier-integrated Controllers (ID Flag Sensors)

Type	Appearance	Size	Model
NPN output		90 × 30 × 65 mm	V680-HAM91
PNP output			V680-HAM81

Special Interface Cables (for V680-HAM91 and V680-HAM81)

Cable length	Model	Appearance
2 m	V680-A60 2M	
5 m	V680-A60 5M	
10 m	V680-A60 10M	

- Note:**
1. The connectors are not waterproof.
 2. The cable length can be extended to a maximum of 10 m.
 3. Normally two Interface Cables are required for 1 Unit. If you do not need to write to ID Tags, or use the address shift or noise check functions, then one Interface Cable is sufficient.

Handheld Reader Writers

Name	Appearance	Model
Model with standard serial connector		V680-CH1D
Model with USB connector and 0.8-m cable		V680-CHUD 0.8M
Model with USB connector and 1.9-m cable		V680-CHUD 1.9M
Models for Zebra Technologies Handheld Terminal		V680-CH1D-PSI
AC Adapter (for V680-CH1D)		V600-A22

Amplifier Unit Special Extension Cable (Amplifier Unit to Controller)

Cable length	Appearance	Model
2 m		V700-A40 2M
3 m		V700-A41 3M
5 m		V700-A42 5M
10 m		V700-A43 10M
20 m		V700-A44 20M
30 m		V700-A45 30M

Note: The cable can be extended up to 40 m. Up to two extension cables can be used.

V680-H01 Antenna Special Cable (Antenna to Controller)

Cable length	Appearance	Model
2 m		V700-A40-W 2M
5 m		V700-A40-W 5M
10 m		V700-A40-W 10M
20 m		V700-A40-W 20M
30 m		V700-A40-W 30M

Note: The cable can be extended up to 30 m. Only one extension cable can be used.

ID Map Manager

Type	Model
Japanese version	V680-A-IMMJP-P02 *
English version	V680-A-IMMEG-P02 *
Chinese version	V680-A-IMMCN-P02 *

* Supported operating system: Windows 7
For details, consult your OMRON representative.

Refer to the data sheet (Cat. No. Q267) for information on the ratings/specifications and the dimensions of accessories and each products.

OMRON Corporation Industrial Automation Company
Kyoto, JAPAN

Contact: www.ia.omron.com

Regional Headquarters

OMRON EUROPE B.V.

Wegalaan 67-69, 2132 JD Hoofddorp
The Netherlands
Tel: (31)2356-81-300/Fax: (31)2356-81-388

OMRON ASIA PACIFIC PTE. LTD.

No. 438A Alexandra Road # 05-05/08 (Lobby 2),
Alexandra Technopark,
Singapore 119967
Tel: (65) 6835-3011/Fax: (65) 6835-2711

OMRON ELECTRONICS LLC

2895 Greenspoint Parkway, Suite 200
Hoffman Estates, IL 60169 U.S.A.
Tel: (1) 847-843-7900/Fax: (1) 847-843-7787

OMRON (CHINA) CO., LTD.

Room 2211, Bank of China Tower,
200 Yin Cheng Zhong Road,
PuDong New Area, Shanghai, 200120, China
Tel: (86) 21-5037-2222/Fax: (86) 21-5037-2200

Authorized Distributor:

© OMRON Corporation 2018 All Rights Reserved.
In the interest of product improvement,
specifications are subject to change without notice.

Cat. No. Q266-E1-01

1018 (1018)